

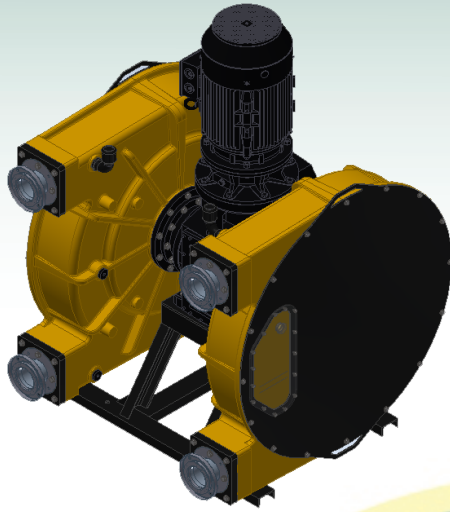

Industrial Peristaltic Pumps

RBT-100 Duplex Data sheet



Capacity:	40 l/rev.
Connections:	2xDN-100
Max. Pressure:	15 bar
Rotor system:	Shoes
Available hoses:	NR NBR EPDM HYPALON

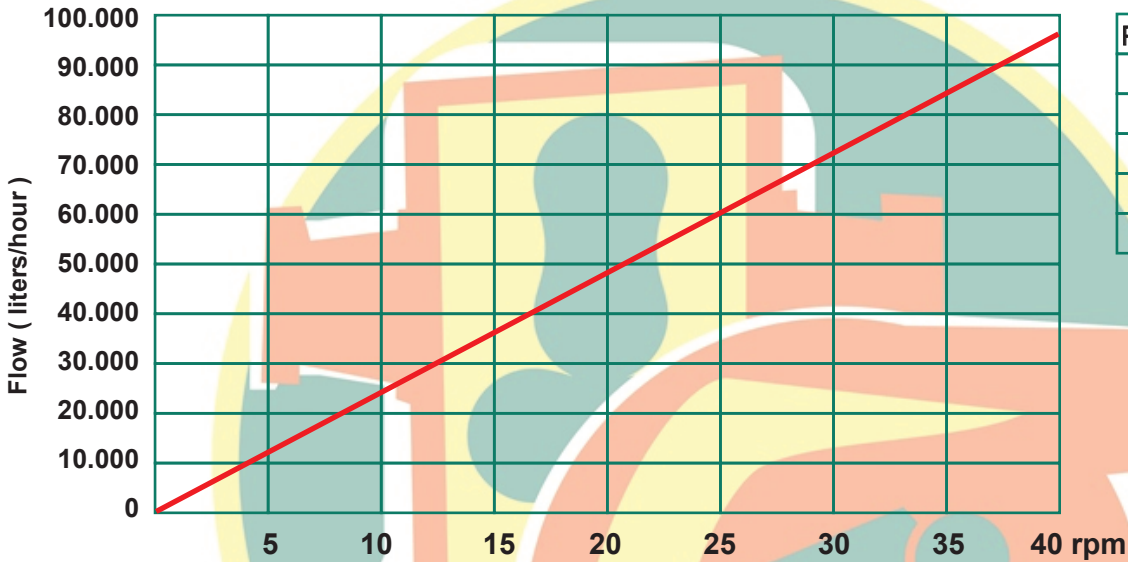

Pressure (bar)	Torque (Nm)
Minimum	6200
5	7600
7,5	10800
10	13400
15	16200

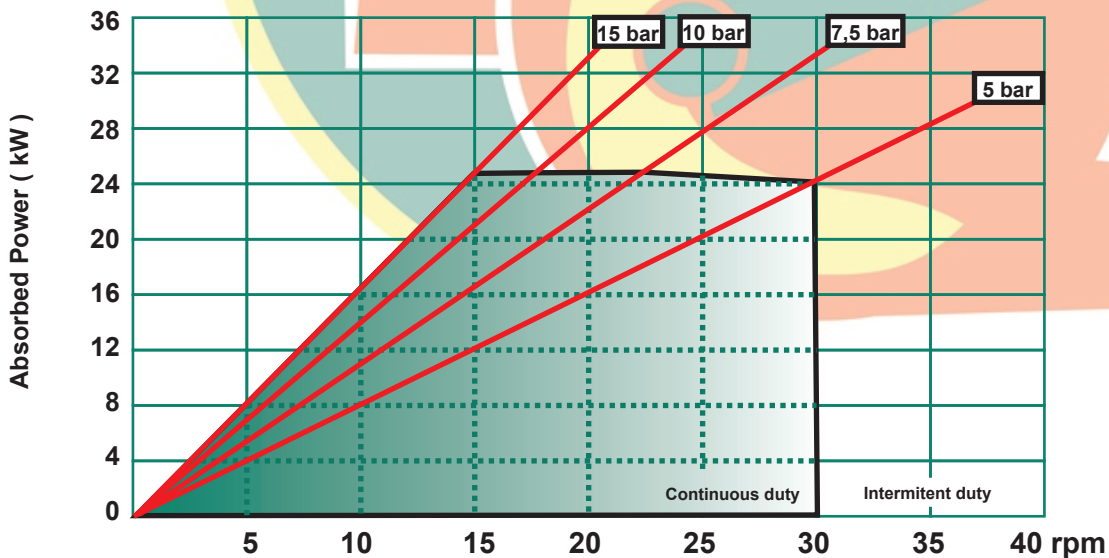

Description	Material	Surface treatment
Pump housing	Cast Iron EN-GJL-250	Polyester powder coated Halar coated (Optional)
Front cover	Steel F-111 / Methacrilate	Polyester powder coated Halar coated (Optional)
Rotor	Nodular Cast Iron EN-GJL-400	Cataphoresis
Shoes	Nodular Cast Iron EN-GJL-400	Hardened
Base plate	Steel F-111 Stainless Steel AISI-304 (Optional)	Polyester powder coated --
Connections	Stainless Steel AISI-304 Polypropylene (Optional) PVDF (Optional)	--

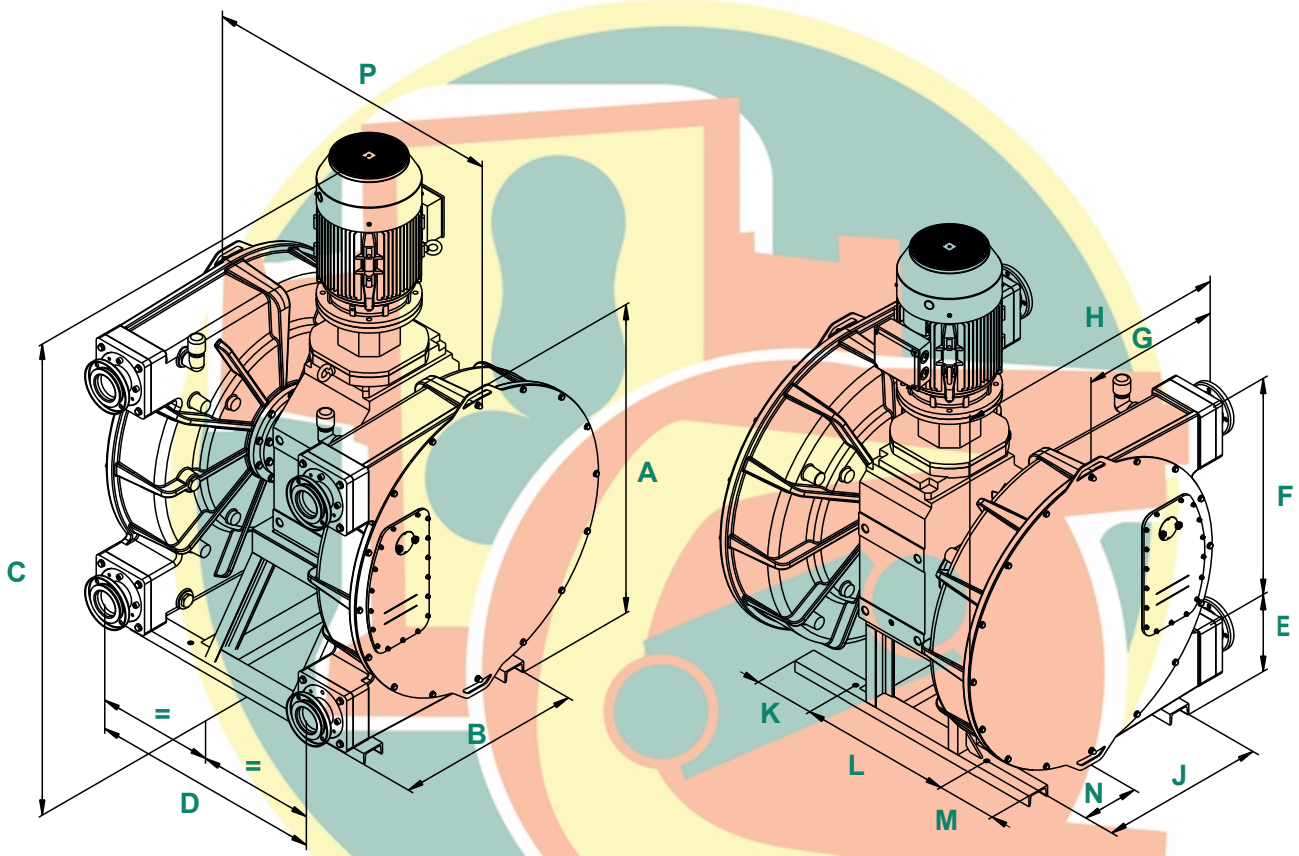

A	B	C	D	E	F	G	H	J	K	L	M	N	P	Connections
1472	854.5	*	1077	271.5	1000	787	1437	754.5	275	700	275	240	1383	DIN DN100

* To confirm according type and power driver.



Bombas Boyser, S.L.

c/ Miquel Martí i Pol, s/n - Pol. Ind. Pla de la Costa
08182 Sant Feliu de Codines - Barcelona - Spain

Tel. +34 93 844 77 78 info@boyser.com

www.boyser.com

